

SMS-RC

Rotating machinery vibration analyzer

Predictive maintenance
Rotor Care Solution



All sectors: pump, compressor, motor, etc.

- Easy to carry : Light weighted portable analyzer
- Easy to operate : 2-step simple setting
- Easy to understand : Result in color signal display





Bearing is the most critical component in rotating machinery.

Malfunctioning bearings can lead to a series of strikes on your production line. To ensure every process proceeds properly, an inspection is a must to do. By doing root cause analysis, you can avoid unscheduled machine shut down. By performing maintenance based on reliable scientific basis, you can extend machine lifetime and meanwhile ease maintenance costs. Even after a third-party repair process, you can't skip the acceptance review mechanism for incoming quality checks.

Goodtech Instrument's in-house algorithms are designed to satisfy the above demands, covering ISO 20816, ISO 10816, ISO1940, and the comprehensive vibration measurement values, visualizing confusing signals to intuitive health indicators.

We used to tell machine conditions by feeling and sound from professionals' experience.

SMS-RC standardizes and quantifies the objective senses into effective and scientific results to accomplish Predictive Maintenance (PdM). **Vibration signal is the initial indicator can reveal early fault the quickest and to prevent unexpected machine shut down,** suitable for all types of rotating machinery, such as pumps, motors, fans, and mechanical conveyors.

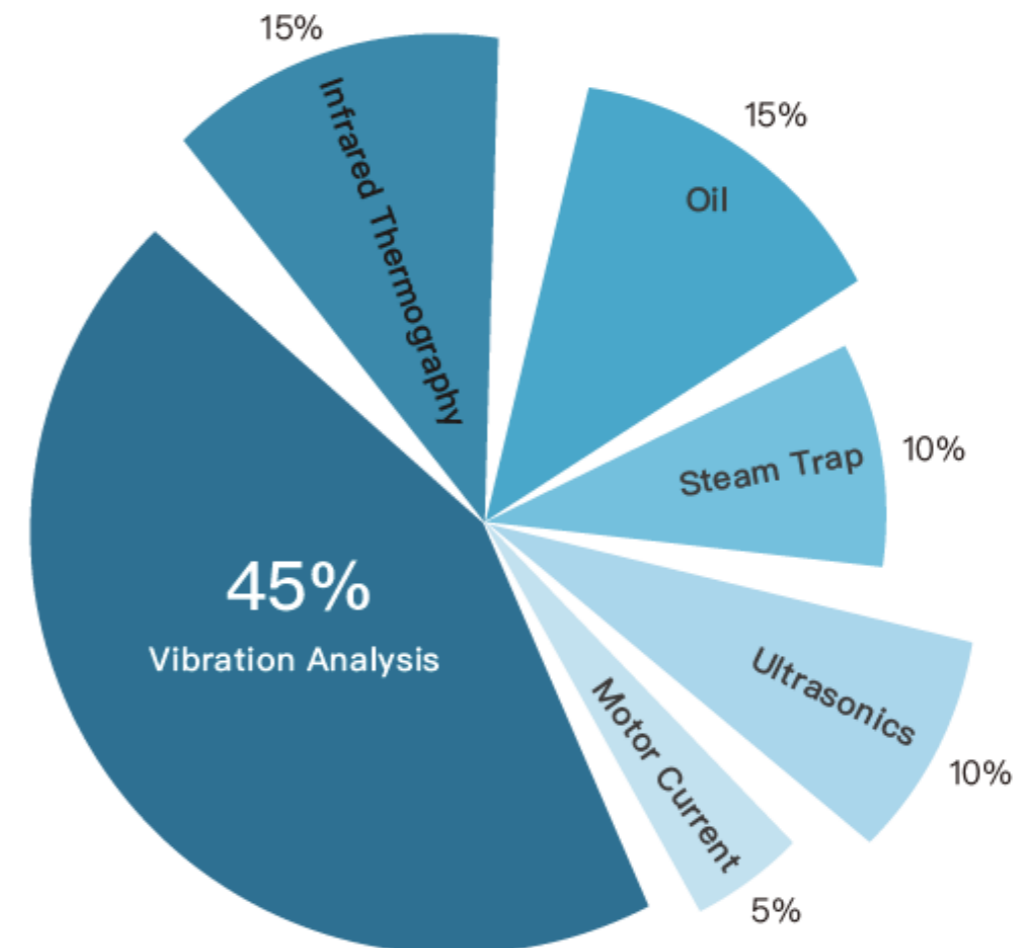

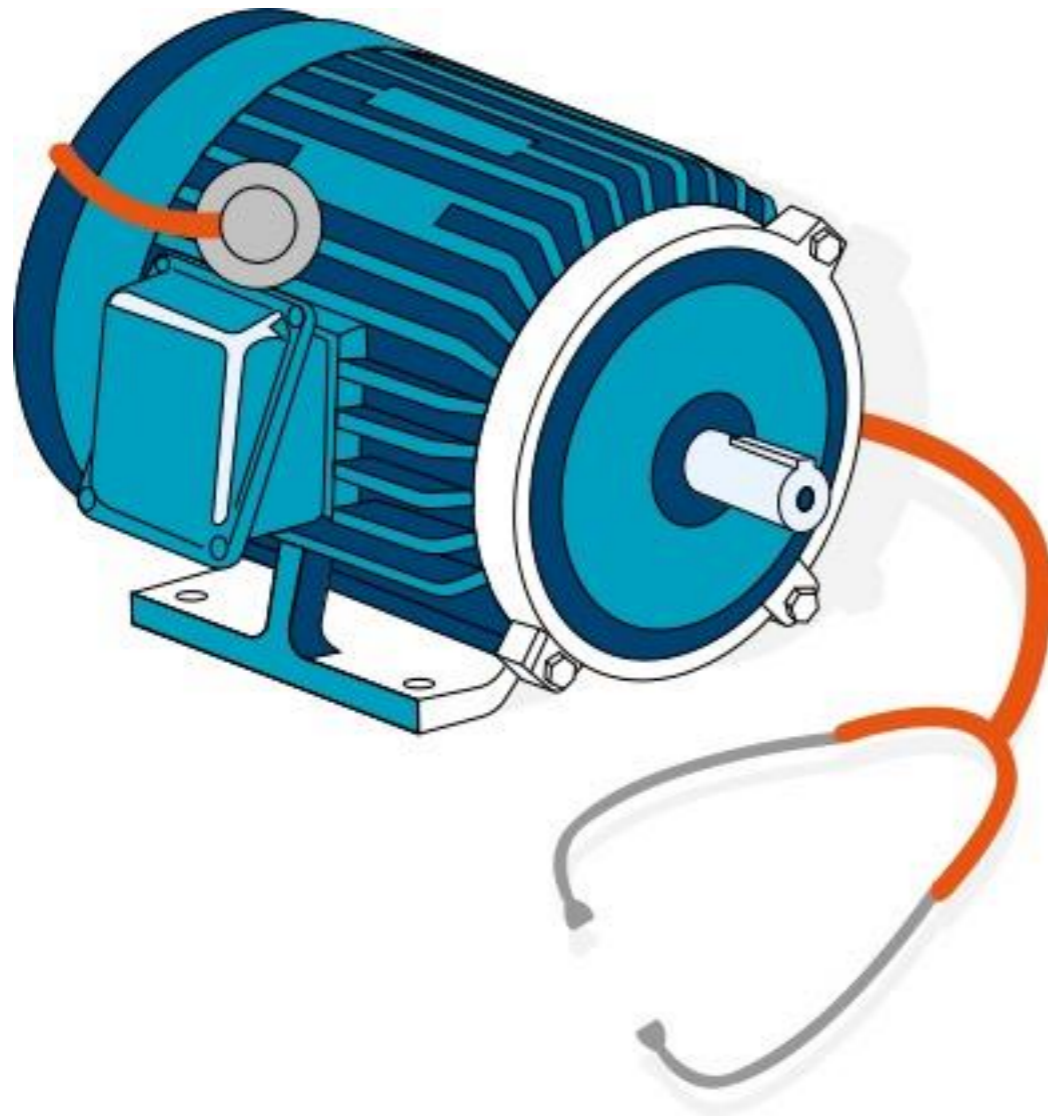

SMS-RC, a rotating machinery vibration analyzer, can be carried effortlessly from site to site thanks to less than 1 kg body weight.

Super easy to operate – ordinary users can diagnose **machine health criticalities** (Good, Satisfactory, Unsatisfactory, Unacceptable) on sharp color display by choosing the respective regulatory standards.

Built-in **spectrum characteristics** patterns offer a cross-comparison for the root cause analysis. Adding **ISO 1940 dynamic balance** and **triple-algorithm vibration meter** into your regular inspection, analysts can accelerate the whole process and give the green light before and after the maintenance.

SMS-RC solves your problems in plant !

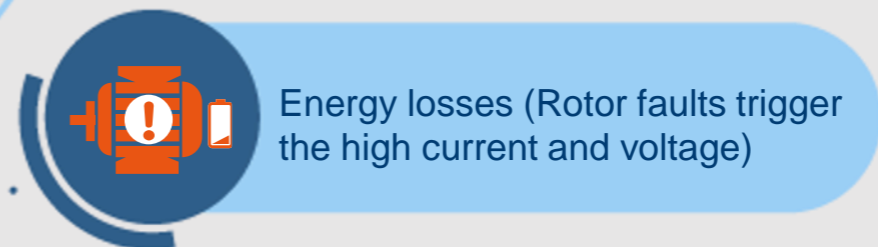
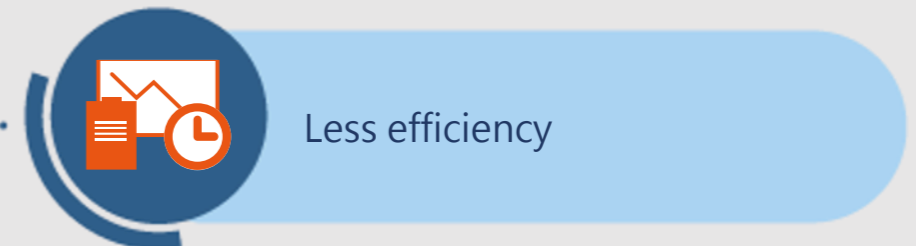
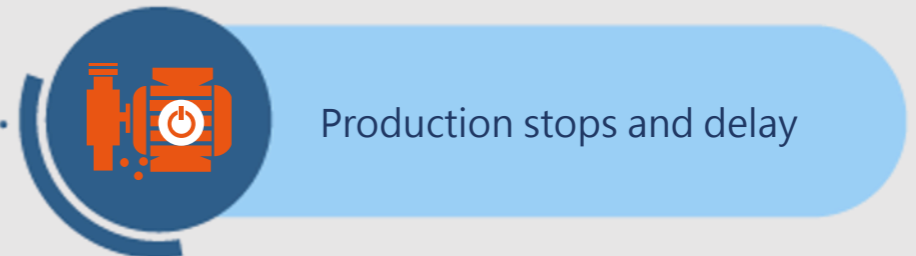
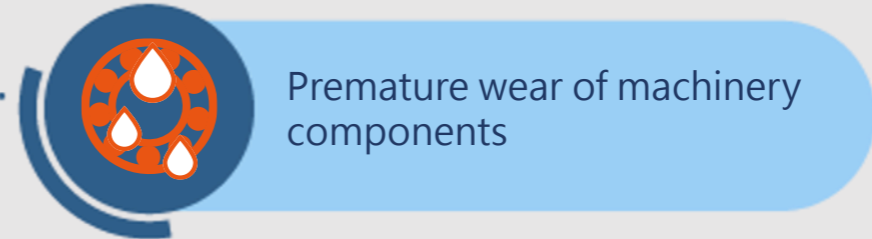

Schedule the next repair appointment
only when SMS-RC recommends you to



Designed function portfolio, simple setting & intuitive interface break the technical boundary. Users, no need to get trained, can PICK UP the analyzer within 30 minutes. A truly budget-friendly yet high-performance analyzer.

Maintenance, repair, and acceptance review should all be based on a scientific basis. SMS-RC standardizes and digitalizes the inspection process, giving a reliable result that you can rely on to cut maintenance fees, reduce excessive maintenance and optimize the acceptance review to **ensure every penny counts for a reason.**

4 functions, All in one

SMS-Rotor Care



ISO 20816,
10816 health
indicator, FFT,
vibration value

ISO 1940
Result of G level

TWF & FFT

Triple-algorithm of
Real-time, Average,
Maximum vibration
values, views in
between Acceleration,
Velocity, and
Displacement



Goodtechnology.com.tw



With built-in ISO 20816 & 10816 standards, you can not only find the vibration value but also learn the holistic health criticalities by **Good, Satisfactory, Unsatisfactory, and Unacceptable four levels**. A sharp color display gives no room for misjudgment. No post-analysis required, prompt on-site result for time-sensitive correction. Integrated Bandpass Filter allows you to have a closer look at the specific frequency range.

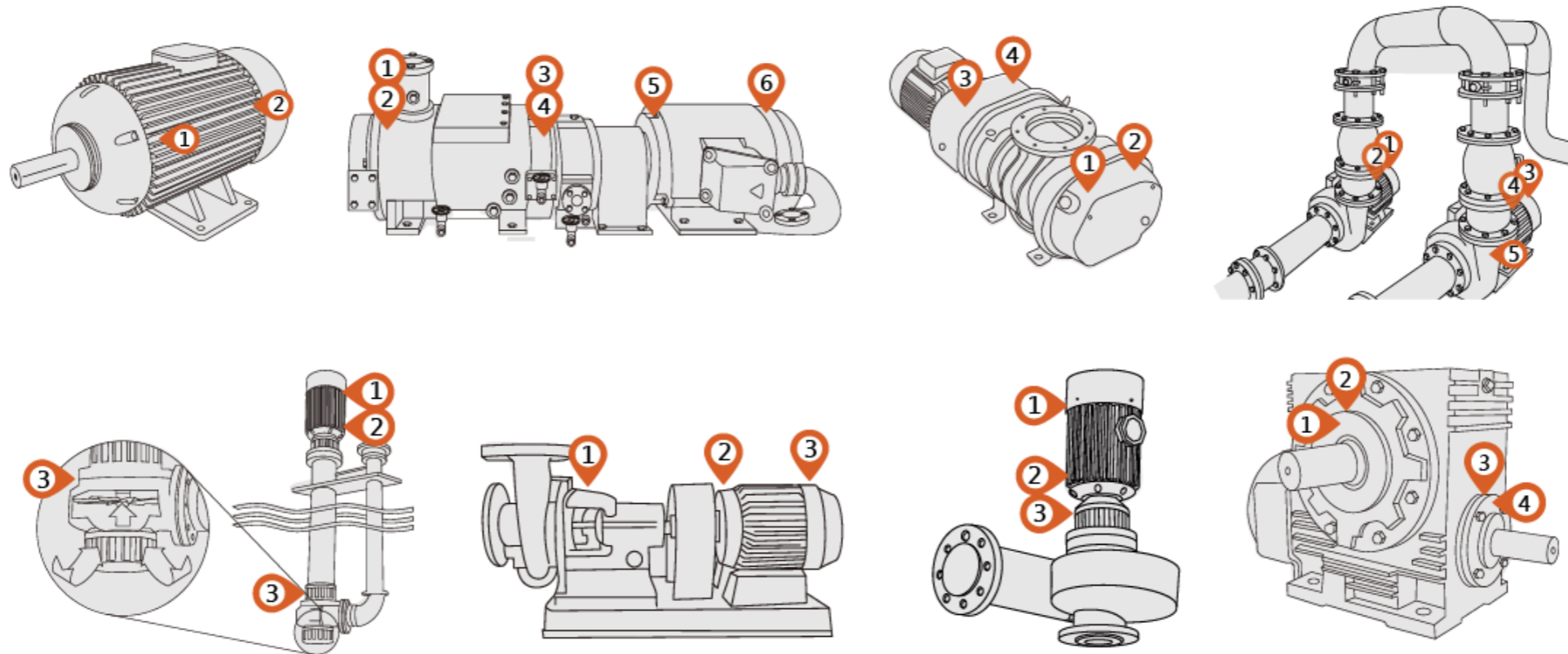

SMS-RC is super easy to operate regardless of expert knowledge levels.

No idea how to get started? We' ve integrated a dozen of pictures of common rotating machines, such as cooling towers, gearbox, windmills, all kinds of pumps...etc. You can simply follow the orange pins to place the sensor and start the diagnosis.

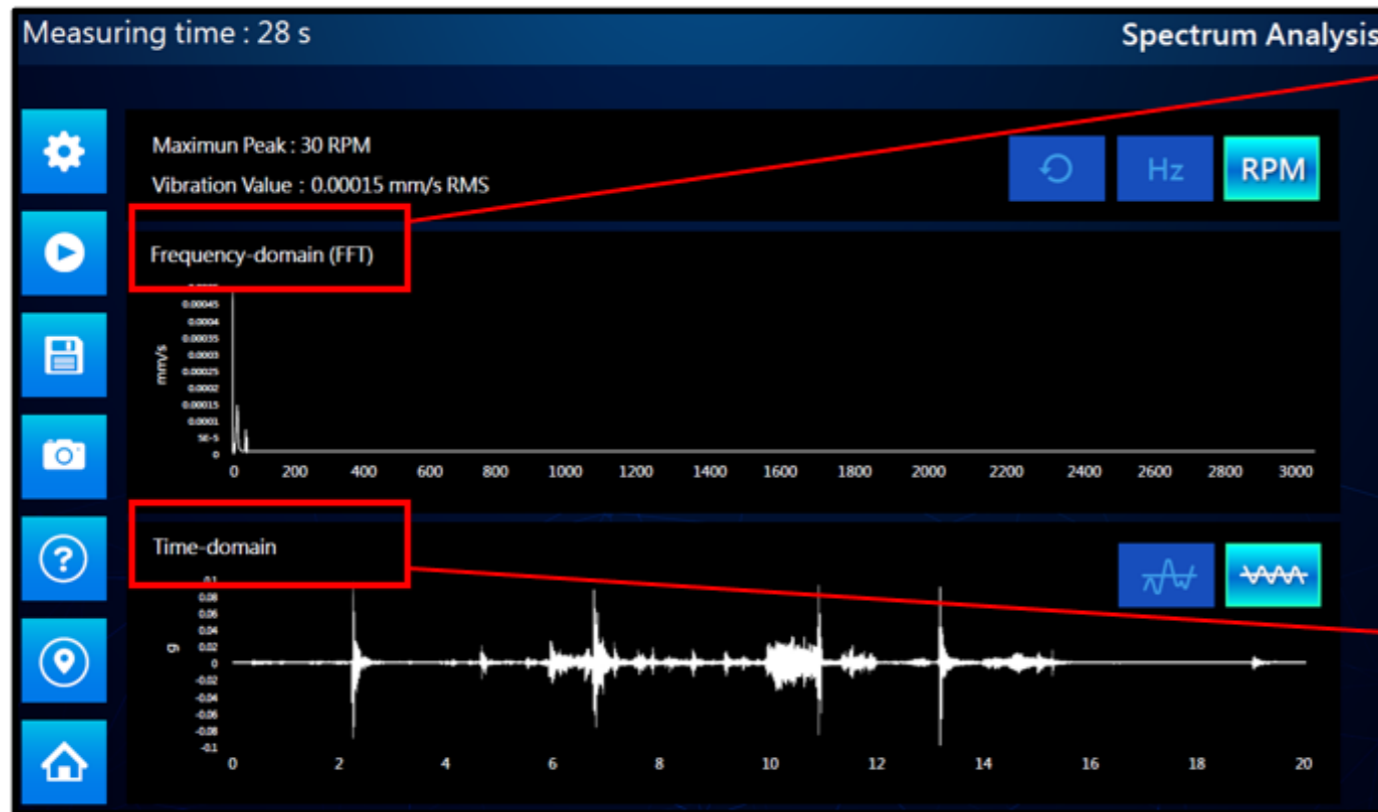

FFT for common characteristic analysis

(misalignment, unbalance, looseness, shaft bending, fluid turbulence, etc.)

TWF for bearing related

faults(Lubrication, Damaged Bearing)

Blade vibration

- Blade frequency (BPF) = number of blades x speed, which is the natural frequency of pumps, windmills and compressors.
- However, if the design is improper, the diffuser is worn, the pipeline is steeply bent, the turbulence is obstructed, or the shaft is eccentric, all will cause high BPF

Vibration characteristics of poor alignment

- The vibration frequency mainly occurs at 1, 2, or 3 times the speed.
- Because most of the misalignment is a mixed misalignment (angle + parallel), the vibration direction comes from both radial and axial directions.

Fluid turbulence

- When the air enters and exits the windmill, sudden changes in pressure or speed will cause turbulence.
- Spoilers usually produce random, low-frequency vibrations, ranging from about 1 to 30 Hz.

Vibration characteristics of mechanical looseness

Regardless of external looseness or internal looseness, the frequency spectrum will show obvious 1x, 2x, 3x...7x, 8x or higher speed frequencies, and the radial and axial directions have the same characteristics. The spectrum of external and internal loosening is usually slightly different.

The built in FFT characteristics pattern is for cross comparison for the advanced analysts.



Increase machine uptime to avoid unpredictable machine break-down.



Routine machinery check-up to prevent unnecessary maintenance and lower the annual maintenance cost.



Maximize production time and optimize product quality.



Acceptance review mechanism for the returning machine from the repairing company.



Automatic analysis

Upgrade from human sense and experience for an efficient & reliable result.



Acceptance review

Double confirmation before and after repair.



Reporting

CSV & JPG measurement results assist your every decisive making.



Equipment measurement

ISO 10816 machine health
ISO 1940 G level
FFT root cause analysis
Triple-algorithm vibration value



Commissioning

Scientific reference to the module change, material change.



IQC & OQC

IQC & OQC on rotating machinery

No need to worry about the **reliability!** SMS-RC has been widely implemented in the most rigorous **vertical market: Semiconductor**. TSMC is not only our prestigious client but a world well-known global IC supplier, who dominates up to 70% chipset capacity.

TSMC has been using SMS-RC for more than 3 years now. **SMS-RC, not only tells machine health, but also does the acceptance review for the claimed“ already repaired motors”**

Overall, **SMS-RC not only saves them tons of maintenance fees, but also precious time & human forces,** allowing TSMC to focus on what they really good at "precise IC manufacturing"!

SMS-RC Target Asset in Semiconductor field





Field :

Semiconductor Industry, Petrochemical Plant, Food Factory, Pharmaceutical Plant, Paper Mill, Panel Factory, Led Factory, Power Plant, Pumping Station, Sewage Treatment Plant, Processing and Manufacturing, Equipment Manufacturers, Maintenance Service Providers, etc.

Target machine:

Pump: vacuum pump, oil pump, sewage pump, etc.

Production equipment: machine tool spindle, cutting machine, etc.

Air compressors: screw, centrifugal, reciprocating air compressors, etc.

Others: cooling towers, exhaust windmills, HVAC, etc.