



pFlow



Ultrasonic Wall-Mount Series

**Clamp-on
Ultrasonic Flow
Meter D118**



Gentos Measurement & Control Co., Ltd.

ABOUT D118

FEATURES AND CASES

D118 Ultrasonic Flowmeter is a state-of-the-art transit time ultrasonic flowmeter. Designed using the latest digital technology and low-voltage broadband pulse transmission.



While principally designed for full-pipe clean liquid applications. The instrument is tolerant of liquids with small amounts of air bubbles or suspended solids found in most industrial environments. Comparing with other traditional flowmeter or ultrasonic flowmeter, it has distinctive features such as high precision, high reliability, high capability and low cost, other features :

- TVT technology designed.
- Less hardware components, low voltage broadband pulse transmission, low consumption power.
- Clear, user-friendly menu selections make flowmeter simple and convenient to use.
- Daily, monthly and yearly totalized flow.
- Parallel operation of positive, negative and net flow totalizes with scale factor (span) and 7 digit display, while the output of totalize pulse and frequency output are transmitted via relay and open collector.



ABOUT D118 SPECIFICATION

PERFORMANCE SPECIFICATIONS

Flow range	$\pm 0.03\text{ft/s} \sim \pm 40\text{ft/s}$ ($\pm 0.01\text{m/s} \sim \pm 12\text{m/s}$)
Accuracy	$\pm 0.5\%$ of measured value (for $\pm 1.5\text{ft/s} \sim \pm 40\text{ft/s}$)
Repeatability	0.15% of measured value
Linearity	$\pm 0.5\%$
Pipe size	1" to 200" (25mm to 5000mm)

FUNCTION SPECIFICATIONS

Outputs	Analog output: 4~20mA, max load 750 Ω . Pulse output: 0~9999Hz, OCT, (min. and max. frequency is adjustable) Relay output: SPST, max 1Hz, (1A@125VAC or 2A@30VDC)
Communication	RS232&RS485
SD Card	Standard 8G SD card Max record: 512 files Record time interval
Power supply	90 to 245 VAC, 48 to 63 Hz. Or 10 to 36VDC
Keypad	22 keys with tactile action
Display	40 character, 2 line (20x2) lattice alphanumeric, back lit LCD.
Temperature	Transmitter: -40°F~140°F (-40°C~60°C) Transducer: -40°F~176°F (-40°C~80°C, standard)
Humidity	Up to 99% RH, non-condensing

PHYSICAL SPECIFICATIONS

Transmitter	NEMA 4X (IP65), Die-cast aluminum
Transducer	Encapsulated design double-shielded transducer cable Standard/maximum cable length: 30ft/1000ft (9m/305m)
Weight	Transmitter: approximately 2.15kg; Transducer: approximately 0.9kg.



Transmitter



Transducer



Pipe strips



Coupling compound



SD card

ABOUT D118 INTERFACE AND SIZE

WIRING DIAGRAM

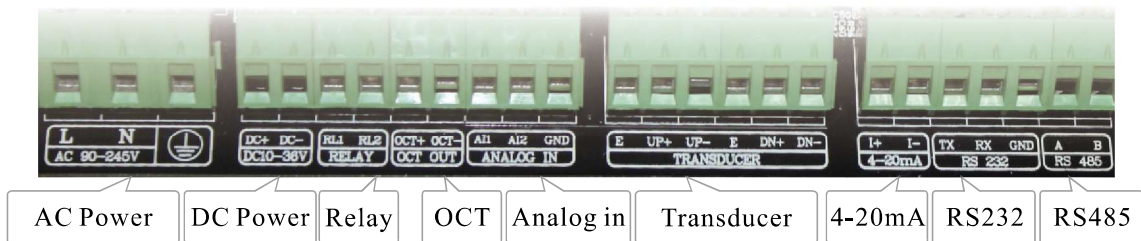

TRANSMITTER DIMENSIONS

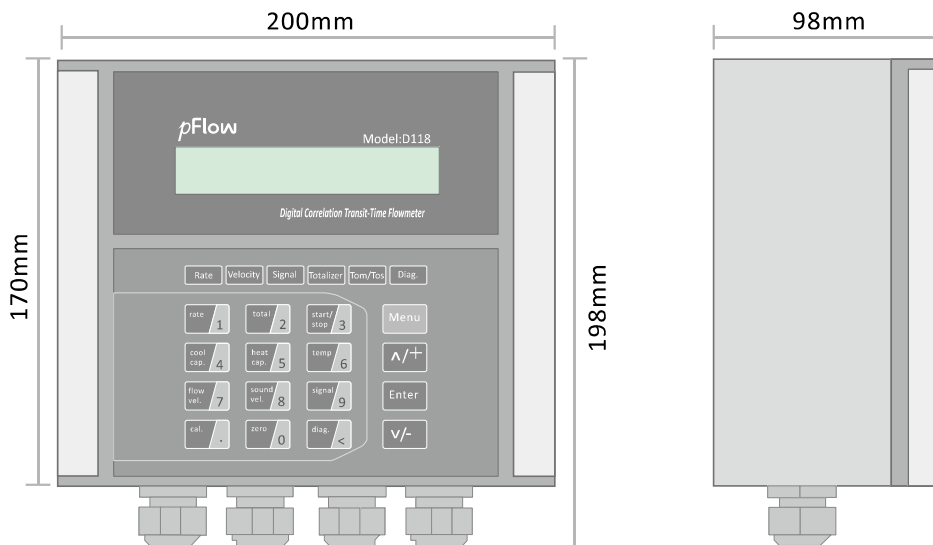

TRANSDUCER (C011)

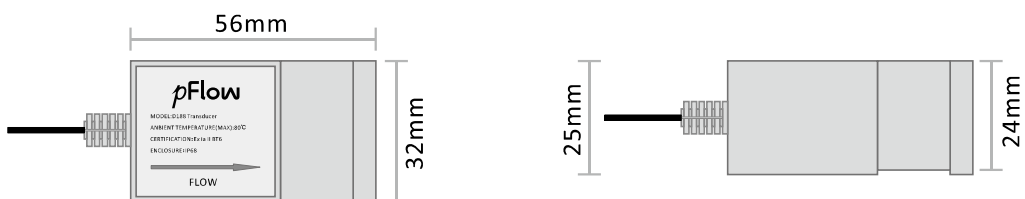

ABOUT D118 TRANSDUCER INSTALLATION METHODS

V METHOD MEASURING PIPE SIZE : 25MM-400MM

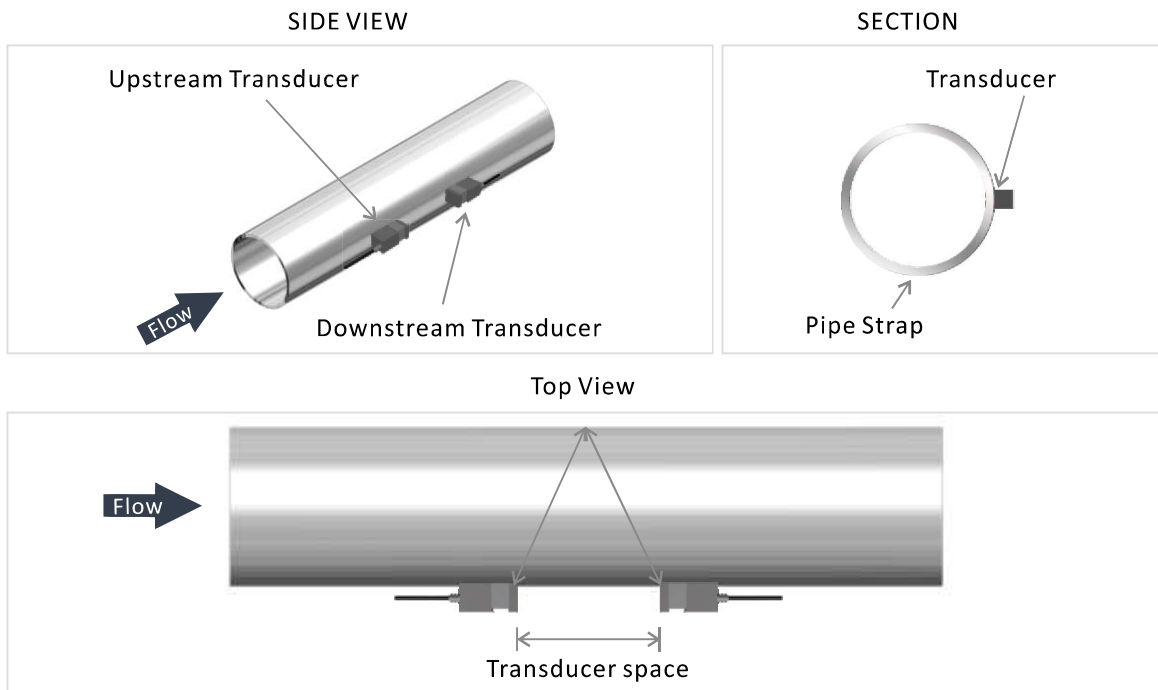

Z METHOD MEASURING PIPE SIZE: 100MM-3000MM

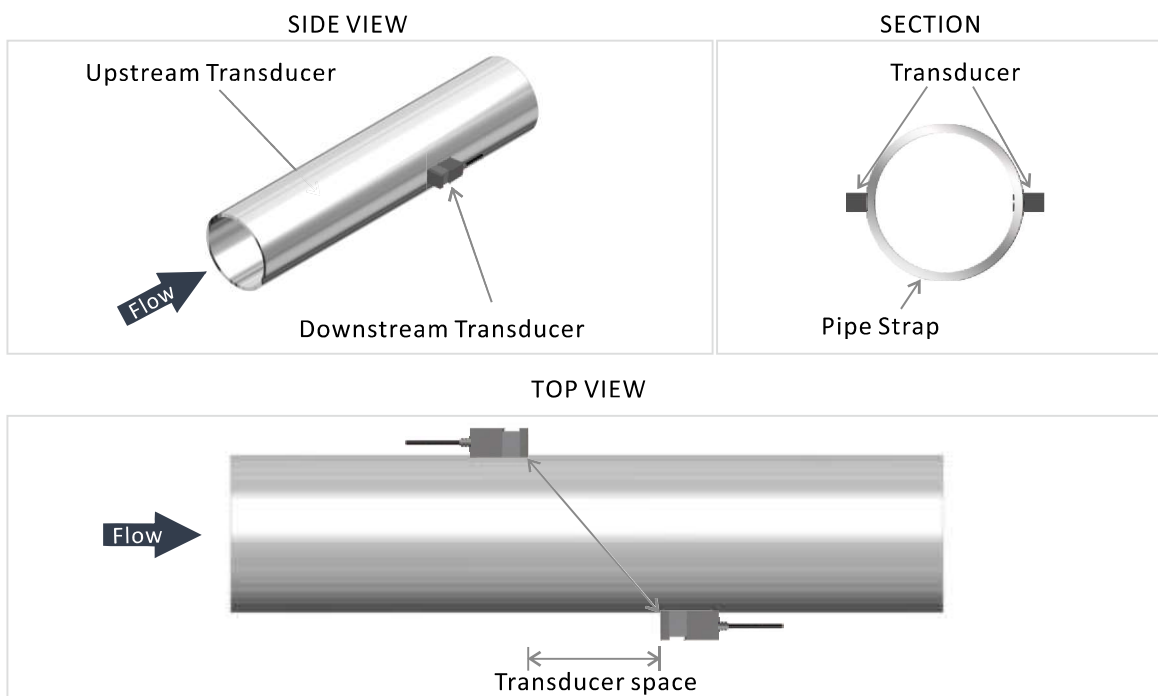

ABOUT D118 INSTALLATION SITE SELECTION

When selecting a measurement site, it is important to select an area where the fluid flow profile is fully developed to guarantee a highly accurate measurement. Use the following guidelines to select a proper installation site:

Choose a section of pipe that is always full of liquid, such as a vertical pipe with flow in the upward direction or a full horizontal pipe.

Ensure enough straight pipe length at least equal to the figure shown below for the upstream and downstream transducers installation.

Ensure that the pipe surface temperature at the measuring point is within the transducer temperature limits.

Consider the inside condition of the pipe carefully. If possible, select a section of pipe where the inside is free of excessive corrosion or scaling.

STRAIGHT LENGTH OF UPSTREAM PIPING

90° Bend

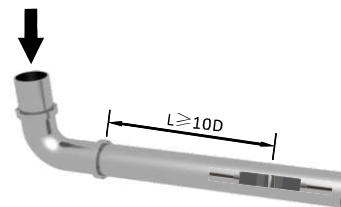

Tee

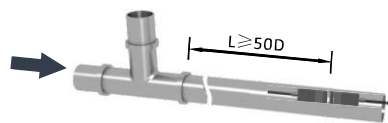

Diffuser

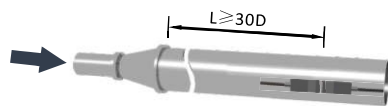

Reduce

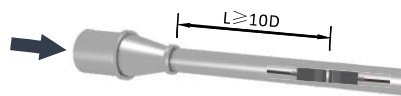

Valve

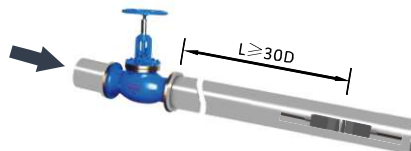

Vertical

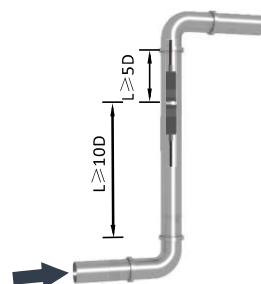

STRAIGHT LENGTH OF DOWNSTREAM PIPING

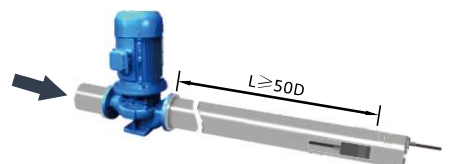
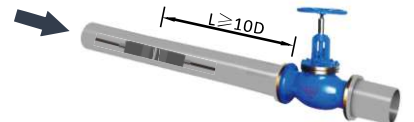
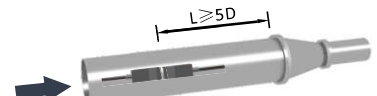
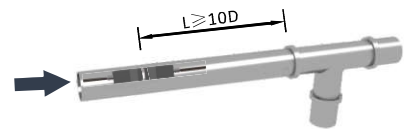
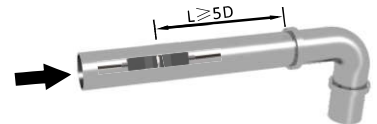

ABOUT D118

ORDERING INFORMATION

MODEL

DESCRIPTION

D118	<p>Digital Correlation Transit Time Flowmeter Installation method: Wall mount 8G SD card high memory data logging, maximum memorize 512 files data. Flow Range: 0.03 ~ ±40ft/s (0.01~ ±12 m/s) Accuracy: ±0.5% of measured value Repeatability: 0.15% Pipe Size Range: 1"~200"(25mm ~ 5000mm) Keyboard: 16 (4×4) touch keys Display: 20*2, alphanumeric, backlit LCD Power supply: 90-250VAC, 48-63 Hz or 10-36V DC Transmitter enclosure: IP65, die-cast aluminum machined enclosure Output: 4~20mADC, OCT pulse output, relay output Communication: RS-232 / RS-485 terminal Modbus Protocol</p>
------	--

CODE

OUTPUT

1	4-20mA, OCT pulse output, relay output, RS-232 / RS-485
2	4-20mA, OCT pulse output, relay output, RS-232 / RS-485, RTD temperature input

CODE

TRANSMITTER ENCLOSURE AREA CLASSIFICATION

1	IP65, die-cast aluminum machined enclosure
2	Explosion-proof enclosure , Ex dia II BT4

CODE

TYPE OF TRANSDUCERS

C011	Clamp on transducer, Operating temperature: -40°F ~ +176°F(-40°C ~ +80°C)
CH020	High temperature Clamp on transducer: 32°F ~ +302°F(0°C ~ +150°C)
W211	Insertion transducer, Operating temperature: -40°F ~ +176°F(-40°C ~ +80°C)
WH101	High temperature Insertion transducer: 32°F ~ +302°F(0°C ~ +150°C)

CODE

TRANSDUCER CABLE LENGTH

030	Standard 30ft (9m)
xxx	Maximum lengthen to 305m(1000ft), per 5m is a lengthen unit.

CODE

TYPE OF TEMPERATURE SENSOR

PT1000	Pt1000 Temperature sensor(0°C ~ +100°C)
--------	---

Standard Model: D118-1-1-C011-030

Description: Standard enclosure with Clamp-on transducers C011, RS232/RS485/OCT/Relay/4-20mA, 9m cable.